

International Conference on Space Optics—ICSO 2010

Rhodes Island, Greece

4–8 October 2010

*Edited by Errico Armandillo, Bruno Cugny,
and Nikos Karafolas*

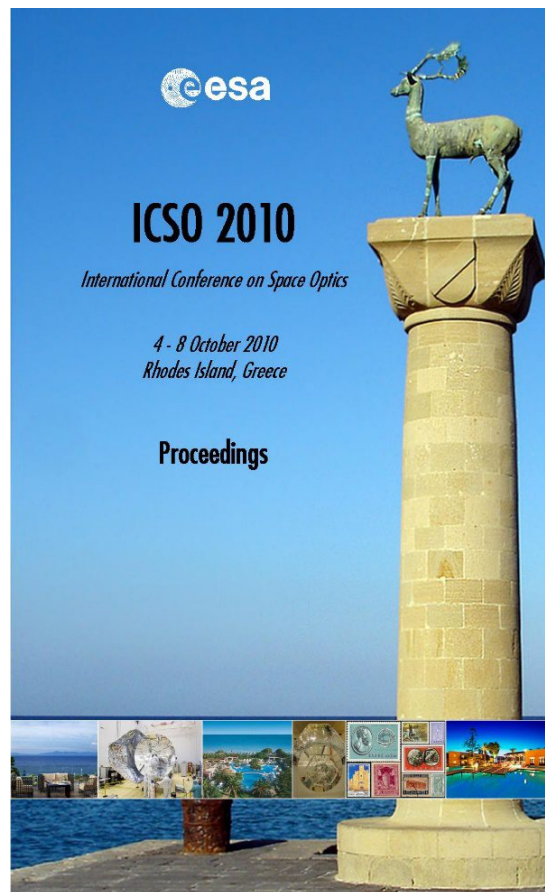

Wide band continuous all-fiber comb generator at 1.5 micron

François Lemaître, Linda Mondin, X. Orlik



International Conference on Space Optics — ICSO 2010, edited by Errico Armandillo, Bruno Cugny,
Nikos Karafolas, Proc. of SPIE Vol. 10565, 105651J · © 2010 ESA and CNES
CCC code: 0277-786X/17/\$18 · doi: 10.1117/12.2309155

WIDE BAND CONTINUOUS ALL-FIBER COMB GENERATOR AT 1.5 MICRON

François Lemaître¹, Linda Mondin², X. Orlik¹

¹ONERA, 2 Avenue Edouard Belin, 31000 Toulouse France

²CNES 18 Avenue Edouard Belin, Toulouse France

I INTRODUCTION

We present an all-fiber continuous optical frequency comb-generator (OFCG) able to generate over 6 nm (750 GHz) at 1560 nm using a combination of electro-optic and acousto-optic modulations. As opposed to numerous experimental setups that use the longitudinal modes of an optical cavity to generate continuous optical frequency combs, our setup doesn't need any active stabilization of the cavity length since we use the intrinsically high stability of radiofrequency sources to generate the multiple lines of the comb laser. Moreover, compared to the work of ref [1], the hybrid optical modulation we use allows to suppress the problem of instability due interferences between the generated lines. We notice that these lines benefit from the spectral quality of the seed laser because the spectral width of the synthesized hyperfrequency and radiofrequency signals are generally narrower than laser sources.

II PRINCIPLES

It is based on the injection of a fibered laser into a loop containing an Erbium Doped Fiber Amplifier (EDFA) and a combination of acousto-optical (AOM) and electro-optical modulators (EOM). The EOM acts as a phase modulator that spreads its input signal into a set of lines that are multiples of F_{EOM} (about 16 GHz). The AOM shifts its input spectrum by F_{AOM} (about 40 MHz), avoiding signal interferences between lines along the multiple cycles. The Erbium Doped Fiber Amplifier (EDFA) compensates the loss into the optical components and maintains the input power p at the input coupler.

The level of each line in the comb depends on three main adjustable parameters that are the fine tuning of F_{EOM} , the relative power p at the input of the coupler, and the modulation index i of the EOM.

- The tuning of F_{EOM} allows the accumulation of the phase modulation from cycle to cycles into the fibered loop, the widest spread is obtained when the length of the loop is an exact multiple of the modulation wavelength.
- The relative power p controls the decreasing power along the cycles.
- The modulation index i_{EOM} of the EOM controls the spreading of each line of the input spectrum, according to the Bessel function $J_k(i_{EOM})$.

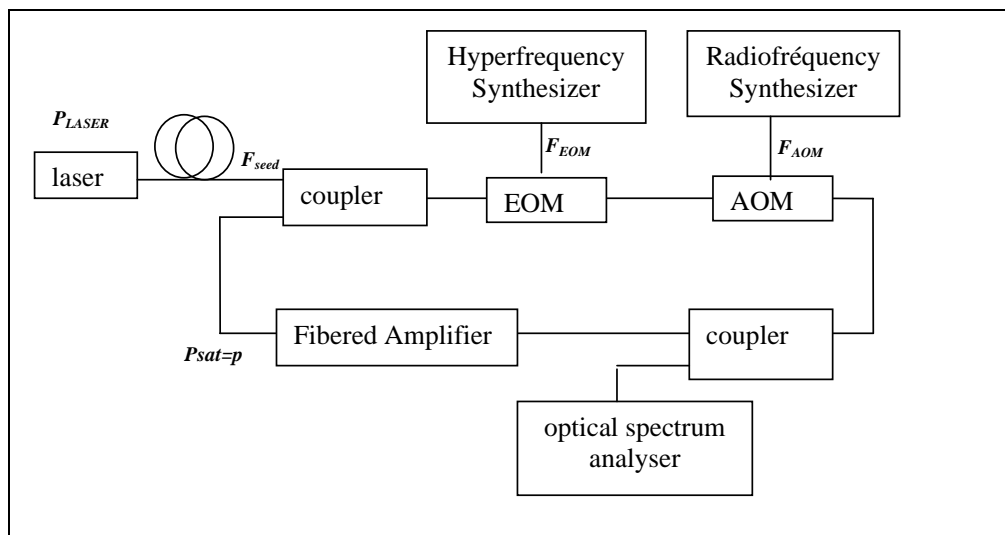

System setup of the comb generator
Proc. of SPIE Vol. 10565 105651J-2

III MODELIZATION and SIMULATIONS

From the seeding laser the modulation effects at the i^{th} iteration in the loop is equivalent to i times the phase modulation in the EOM followed by i times the frequency shift by F_{AOM} . Considering that the fiber loop length is not exactly a multiple of the modulation wavelength ($\Delta\varphi$ expresses the remaining phase), the modulus of the overall combined modulation index I_{ii} for the i^{th} iteration can be written as:

$$I_{ii} = I_{EOM} \left| \sum_{k=1}^{k=i} \exp(\Delta\varphi.k.j) \right| \quad j = \sqrt{-1} \quad \text{Eq 1}$$

Then, the instantaneous phase at the i^{th} iteration has the expression:

$$\varphi_i(t) = (\omega_0 + i.2\pi F_{AOM})t + I_{ii} \cdot \sin(2\pi F_{EOM} t) \quad \text{Eq 2}$$

Considering that the EDFA operates in saturated mode and assuming that no losses exists in other optical components, the constant output power leads to an effective gain equals to $(1+P_{laser})^{-1}$. This implies that the overall power of the spectrum at the i^{th} iteration equals $(1+P_{laser})^{-i}$ and decreases exponentially. Then the corresponding power spectrum at the i^{th} iteration can be expressed by:

$$|S_i(\omega)| = (1 + P_{laser})^{-i} \sum_{k=-\infty}^{k=\infty} \partial(2\pi F_{seed} + i.2\pi F_{AOM}) J_{|k|}^2(I_{ii}) \quad \text{Eq 3}$$

As the produced lines never overlaps (as $F_{AOM} \ll F_{EOM}$), the global observable spectrum is simply the sum of the above mentioned $|S_i(\omega)|$.

At large scale the produced spectrum appears as a comb of lines separated by F_{EOM} . Practically these lines can be seen with an optical spectrum analyzer. A closer look into each line exhibits a set of lines separated by F_{AOM} , corresponding to the contribution of iterations at the same harmonic rank of F_{EOM} . These lines can be seen only with a microwave spectrum analyzer after mixing with the reference laser. It is noticeable that the exponential decreasing power versus iterations mentioned above concerns $|S_i(\omega)|$ that is a set of lines that spreads very widely ; this doesn't implies an exact exponential decreasing of the power in the lines of the same harmonic rank of F_{EOM} .

Optimizing the parameters for the wider extension is not trivial, except for $\Delta\varphi$ because wide spectral extensions are obtained with high modulation index: this requires setting $\Delta\varphi$ close to 0. But the choice of the other parameters remains tricky because of the oscillating behavior of the Bessel function. This is the reason why a simplified simulator has been built; whose goal is to test the influence of each parameter. In our simulation, the EDFA gain is assumed flat.

As example, the influence of the relative power p is shown in the figure below: with $p=5\%$ the decreasing is quite slow (a) but the line corresponding to the 30th harmonic of F_{EOM} spreads over 80 lines (b) ; taking $p=80\%$ there is less power in the 30th harmonic (c), but it is spread into less lines (d).

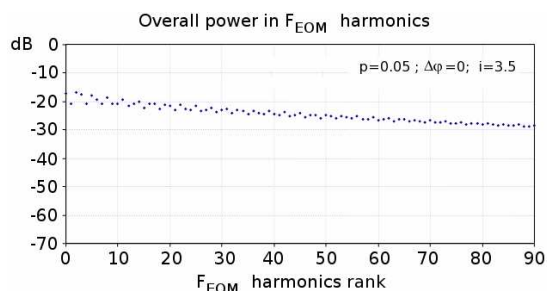

a) decreasing power versus harmonics with $p=5\%$

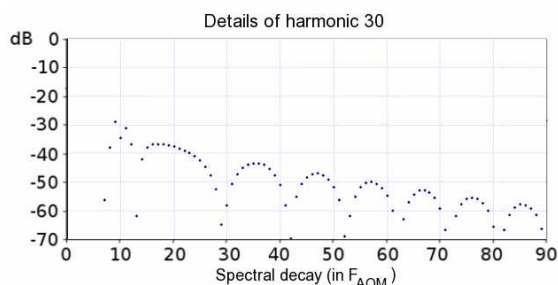

b) details of the 30th harmonic with $p=5\%$

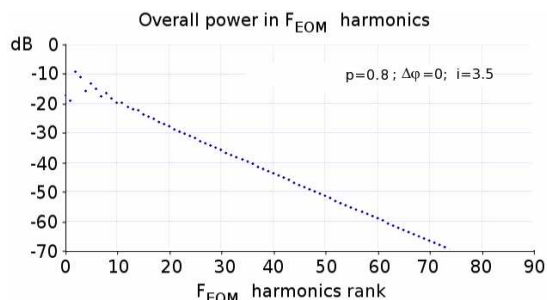

c) decreasing power versus harmonics with $p=80\%$

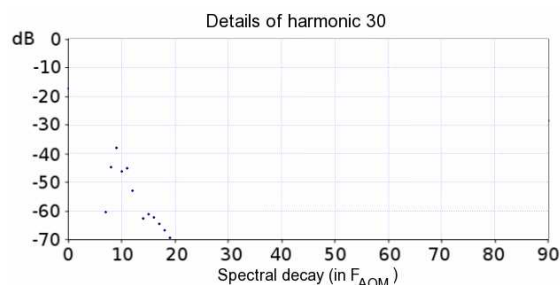

d) details of the 30th harmonic with $p=80\%$

IV EXPERIMENTAL RESULTS

The setup parameters are: $\{F_{EOM}=16 \text{ GHz}, F_{AOM}=40 \text{ MHz}, F_{\text{laser}}=1560 \text{ nm}, \text{seed laser coupling}=10\%$. Tests with optical spectrum analyser (fig below) show clearly the influence of the tuning of F_{EOM} : a detuning of about 100 kHz produces a spectral extension from 1 nm to 6 nm. It can be noticed that the spectral characteristics of the EDFA appears in the power pattern in the maximum spread.

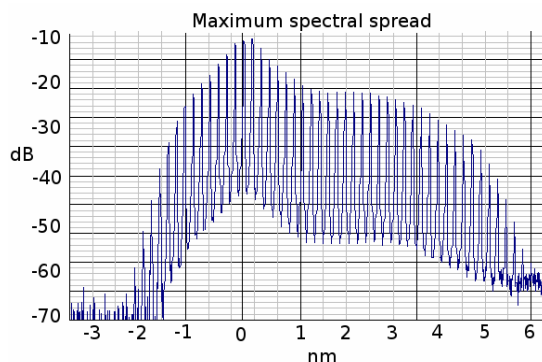
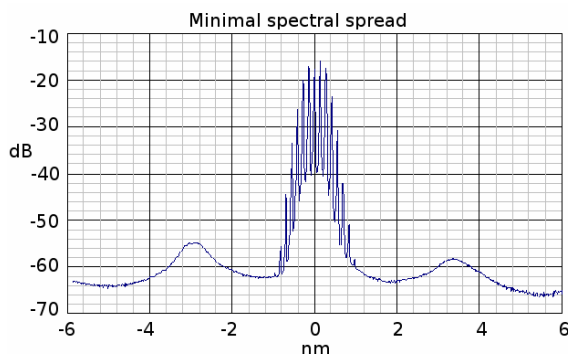

Tests were carried out after mixing the output of the comb generator with the seed laser. Line identification can be tricky because of the spectrum folding. Due to the frequency limit of the spectrum analyser (20 GHz), it is only possible to see the first harmonic. With no electro-optic modulation, the exponential decreasing rate versus parameter p appears clearly in the figure below (right: $p=5\%$, left: $p=80\%$).

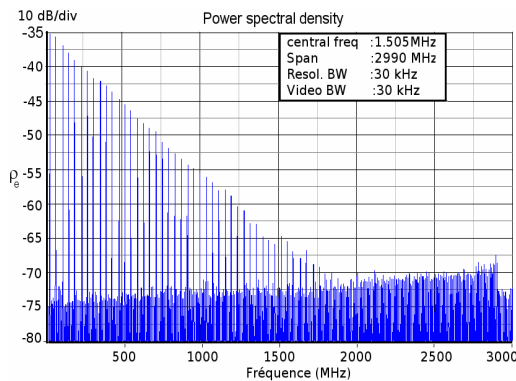
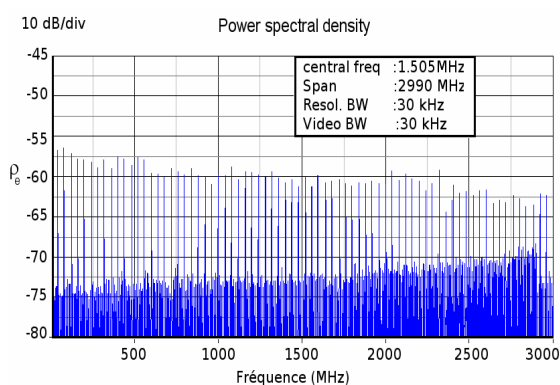

A closer look around the first harmonic (below) shows the set of lines whose levels depend on the chosen parameters. They have the spectral quality of the seed laser provided that microwave signals are produced by good quality synthesizers.

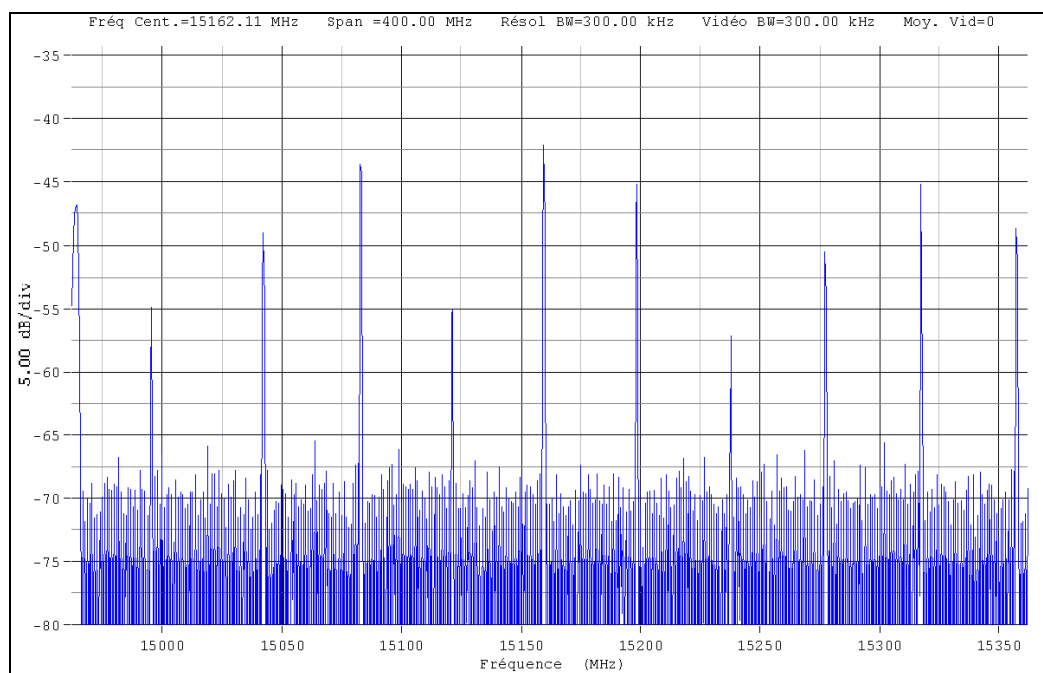

V CONCLUSION

We have proposed a combination of electro-optic and acousto-optic modulations in order to build a stable all-fiber continuous optical frequency comb-generator (OFCG) able to generate optical lines over 6 nm (750 THz) at 1560 nm. On the contrary to most previous works, we don't use longitudinal modes of an optical cavity and as a consequence don't need any active stabilization of the fiber loop. Taking advantage of the spectral characteristics of the radiofrequency sources used for the optical modulations, the spectral characteristics of the generated optical lines are just imposed by the ones of the seed laser. We notice that the technique proposed is not restricted to the near infrared region. In future works, we plan to broaden the spectrum using optimized amplifiers and optical modulators; to perform a fine characterization of the generated optical spectrum (especially the relative phase noise between lines) and to extract a selected line by injection in a DFB laser. Numerous applications can be found in laser (frequency and noise characterization), spectroscopy, distance measurements and in the topic of cooling atoms where it becomes possible to generate with a single laser source, lines needed to cool, to manipulate and to characterize optical molasses and Bose-Einstein condensates.

VI REFERENCES

[1] S.Bennett, B.Cai, E. Burr, O.Gough, and A. J. Seeds "1.8-THz Bandwidth, Zero-Frequency Error, Tunable Optical Comb Generator for DWDM Applications" *IEEE Photonics Technology Letters*, VOL. 11, NO.5, MAY 1999